

荷田歯科 kada dental

荷田歯科機器・器具・用品の通販



ANDY®  
上海汉缔

CE 0123

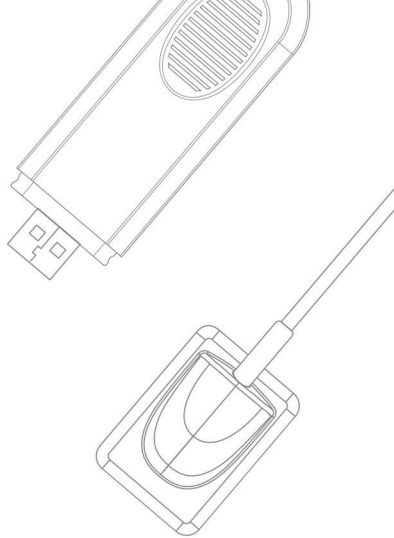

# HDR

300/400/500/600

数字化口腔X射线成像系统  
Digital Dental X-ray Imaging System

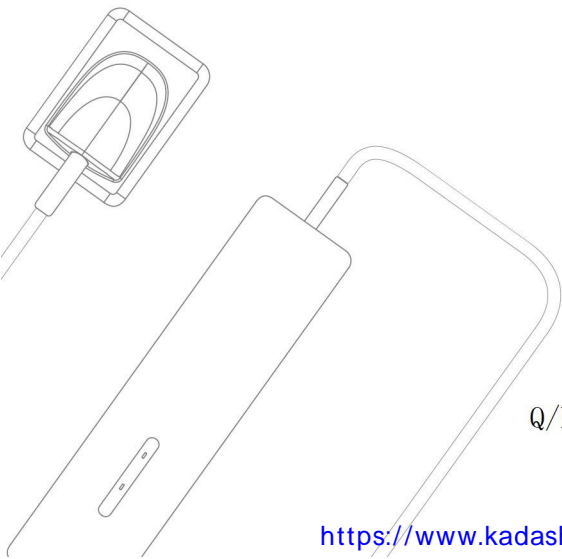

Q/HD 14.73-08-SM V1.0

<https://www.kadashika.jp>



# Preface

Dear users:

Thank you for using Handy Medical's Digital Dental X-Ray Imaging System HDR-300/400、HDR-500/600 and the trust to Handy Medical's products. We will provide our best to ensure the satisfaction when you using the Digital Dental X-Ray Imaging System HDR-300/400、HDR-500/600 .

The Digital Dental X-Ray Imaging System HDR-300/400、HDR-500/600 is operated through the software HandyDentist. HandyDentist is designed to take full advantage of HDR-300/400、HDR-500/600 . To get the best imaging and processing quality, the combine between HDR-300/400、HDR-500/600 and HandyDentist is necessary.

To ensure your safety and effective use of the Digital Dental X-Ray Imaging System HDR-300/400、HDR-500/600 , please read the manual carefully before use.

Handy Medical remind: Any copy of the contents in this manual is not allowed without the permission of Handy.

## Content

1. Notice.....	1
1.1 Indication of Use.....	1
1.2 Brief Introduction of this Manual.....	1
1.3 Manufacturer.....	1
1.4.Packing.....	1
1.5 Symbols.....	1
2. Safety issue.....	2
2.1 Check Sensor and controller before using them.....	2
2.2 Protect Sensor from Potential ESD Damage.....	2
2.3 Do Not Touch Exposed Connectors on Non-Medical Equipment and the Patient at the Same Time.....	2
2.4 Ensure Proper System and PC Workstation Installation and Operation.....	2
2.5 Safety Classifications.....	2
2.6 Conditions required in operation, transportation, and storage.....	2
3. Waste Electrical and Electronic Equipment.....	3
3.1 Background.....	3
3.2 WEEE Marking.....	3
3.3 Reporting.....	3
3.4 WEEE from Users other than Private Households.....	3
3.5 Information for Reuse Centers, Treatment and Recycling Facilities.....	3
3.6 Warning and Safety Instructions.....	3
3.7 Hygiene and Disinfection Instruction.....	4
4. Handy Sensor General Introduction.....	4
4.1 Functional Components.....	4
4.2 Technical Specifications.....	5
4.3 Sharing the Sensor Between Rooms.....	5

---

4.4 Using the different Positioning Systems.....	5
4.5 Attentions.....	5
5. Imaging Software General Introduction.....	6
5.1 Computer System Requirements.....	6
5.2 Imaging Software.....	6
6. Working Sketch.....	6
7. Driver Installation.....	7
8. Software Installation.....	8
9. Register Key.....	10
10 Install Calibration File.....	11
11 Software Operation.....	11
12 Acquiring an Image.....	20
12.1 Preparing the HDR sensor.....	20
12.2 Preparing for Acquisition.....	20
12.3 Launching the X-Ray.....	21
12.4 How to get X-Ray Image.....	21
13. Disinfection and cleaning.....	24
14. Maintenance.....	24
14.1. Visual Inspection.....	24
14.2. Periodic Maintenance.....	24
14.3. Cable Care.....	25
14.4. Damaged or Non-Functioning Sensor.....	25
15. Warranty.....	25
16.Adjust exposure x-ray dose. ....	25
17.Diagnose Error Message.....	26

Annex A. EMC table.

中文说明书 在 本说明书第31 页

## 1. Notice

### 1.1 Indication of Use

The Digital dental X-ray imaging system is intended to generate intraoral x-ray image ,require to working with x-ray source and imaging software in dental clinic for dentist and orthodontists.

### 1.2 Brief Introduction of this Manual

This manual consist of the safety issue, HDR-500 and HDR-600 brief introduction, software introduction, how to use sensor and the warranty policy.

### 1.3 Manufacturer

Manual Name: Digital Dental X-Ray Imaging System Manual

Revision Number: 01

Print Date: Jan, 2015

The Brand names and logos reproduced in this manual are copyright.

Handy is a trademark of Handy used under license.

The system shall be in accordance with IEC60601-1. The person connect the product to the host computer shall insure its compliance.

CE 0123

Manufacturer



Shanghai Handy Medical Equipment Co., Ltd  
 2<sup>nd</sup> Floor, Blg 3, No.2688 Jinqu Rd., Baoshan District, Shanghai 600444 China

European Representative:











Shanghai International Holding Corp.GmbH

### 1.4.Packing

- |  |      |
|--|------|
| 1. Digital Dental X-Ray Imaging System | 1pc  |
| 2. CD                                  | 1pc  |
| 3. Manual                              | 1pc  |
| 4. Holder                              | 1pc  |
| 5. Warranty and Quality Control Card   | 1 pc |

### 1.5 Symbols

Marking and Labeling Symbols

Symbol	Description
	Caution , refer to accompanying documentation
	Class-II Device
	Type BF applied part
<b>SN</b>	Manufacturer's serial number
	MANUFACTURE Manufacturer's name and address
	FRAGILE Contents of the transport package are fragile therefore it shall be handled with care
	THIS WAY UP Indicates correct upright position of the transport package.
	KEEP AWAY FROM RAIN Transport package shall be kept away from rain.
	Antiroll
	Max and Min. temperature
	Indicates that in the European Union, at the end of product life this device must be disposed of in accordance with the requirements of the Waste Electrical and Electronic Equipment (WEEE) directive 2002/96/EC
<b>CE</b>	Conforms to European Union Medical Devices Directive (MDD) 93/42/EEC
	EU Representative Address

## Marking and Labeling Symbols

### Label Location

The following Figure indicates the label locations of The HDR-500 and HDR-600 Systems.

Figure 1 HDR-500 and HDR-600 Label Locations

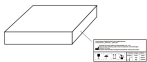

## 2. Safety issue

### 2.1 Check Sensor and controller before using them

Before each usage, check the outer surface of the Sensor and controller for any signs of physical damage or defect. Sensor and controller surfaces should have a smooth finish, with no evidence of chipping or damage. If detected, contact your local distributor of this product for further instructions.

### 2.2 Protect Sensor from Potential ESD Damage

Like other electronic devices, Sensor is susceptible to electrostatic discharge (ESD), particularly when the device is used in or around carpeted areas or low humidity environments. During cable replacement, when Sensor contacts are exposed, it is especially important to protect the device from potential ESD damage. Touching a metal surface prior to replacing the cable will reduce the risk of damaging Sensor components by accidental static discharge. The use of anti-static floor mats or floor treatments (for example Staticide 6005/6002) will also help eliminate static build-up in your office.

### 2.3 Do Not Touch Exposed Connectors on Non-Medical Equipment and the Patient at the Same Time

When the Sensor and controller are in use, avoid touching exposed connectors on non-medical electrical equipment and the patient at the same time. The human body is capable of conducting electrical current and may cause a shock hazard to patients if appropriate safety practices are not observed.

### 2.4 Ensure Proper System and PC Workstation Installation and Operation

The Sensor and controller have been determined to be in accordance with international safety standards and are deemed suitable for use within the patient area, which extends from the patient for a distance of 5 ft (1.5m). To comply with these standards, do not operate non-medical equipment (such as a PC workstation) inside the patient area. Outside the patient area, the presence of approved non-medical grade equipment and Listed / Approved / IEC 60950-1 certified Information Technology

Equipment (ITE) computer equipment is acceptable. The host computer (PC workstation) should be CE-approved and conform to the Low Voltage [73/23/EC] and EMC Directive [89/336/ERC]. The system shall be in accordance with IEC60601-1-1. The person connect the product to the host computer shall insure its compliance. Also, to help ensure optimal performance, ensure that all software programs residing on the workstation are virus-free and have been adequately tested so they will not impact imaging applications after installation. Any questions please contact your local distributor

### 2.5 Safety Classifications

Safety Type: Class-II BF

Power: DC5V Maximum 200MA. Rate of Work: Max 1W

Degree of protection against water resistance: IPX7 (Only applicable for the sensor head part.)

Non AP equipment, non APG equipment

Mode of operation: Continuous operation

### 2.6 Conditions required in operation, transportation, and storage

#### 2.6.1 Operating conditions

Environment Temperature : +10℃～+40℃

Environment relative humidity : ≤95%;

Air pressure : 860hPa~1060hPa;

### 2.6.2 Transport and Storage conditions

Environment Temperature: -25℃~+60℃;

Environment relative humidity : 10%~93%;

Air pressure : 860hPa~1060hPa;

## 3. Waste Electrical and Electronic Equipment

### 3.1 Background

The European Union's Waste Electrical and Electronic Equipment (WEEE) Directive (6002/96/EC) has been implemented in member states as of August 13, 6005. This directive, which seeks to reduce the waste of electrical and electronic equipment through re-use, recycling, and recovery, imposes several requirements on producers. Handy Medical and its Dealers are committed to complying with the Directive.

### 3.2 WEEE Marking

All Handy products subject to the WEEE Directive and shipped after August 13, 6005 will be compliant with the WEEE marking requirements. These products will be identified with the "crossed-out wheeled bin" WEEE symbol shown below, as defined in European Standard EN 50419, and in accordance with WEEE Directive 6002/96/EC.



This "crossed-out wheeled bin" symbol on the product or on its packaging indicates that this product must not be disposed of with other unsorted municipal waste. Instead, it is user's responsibility to dispose of EE waste equipment by handing it over to a designated collection point for the reuse or recycling of waste electrical and electronic equipment. The separate collection and reuse or recycling of Electrical & Electronic waste equipment will help to conserve natural resources and ensure that it is recycled in a manner that protects the environment and human health. For more information about where you can drop off your waste equipment for recycling, please contact your local officials.

### 3.3 Reporting

According to the WEEE Directive, Handy Medical or its Dealers will ensure that information needed to calculate the financial obligations with respect to EEE products will be provided as required.

### 3.4 WEEE from Users other than Private Households

According to the WEEE Directive, Handy Medical or its Dealers will fulfill its obligations for the management of WEEE from users other than private households.

Furthermore, as required by the WEEE Directive, in order to enable the date upon which the equipment was put on the market to be determined unequivocally, a mark on the equipment will be placed to specify that the equipment was put on the market after August 13, 6005.

### 3.5 Information for Reuse Centers, Treatment and Recycling Facilities

After August 13, 6005, and as required by the WEEE Directive, Handy Medical or its Dealers will provide reuse, treatment, and recycling information for each type of new EEE put on the market within one year of the date in which the equipment is put on the market.

Information will include the different EEE components and materials as well as the location of substances in these items. The information will be provided as a printed document or in electronic media (on CD-ROM or by web download, for example)

### 3.6 Warning and Safety Instructions

#### For Device:

- Read and comprehend this Safety Instruction before using the HDR500/600 Systems.
- The operation and maintenance of this device must be taken charge by you. This device only can be operated by the legally qualified persons. If necessary, have a authorized qualified technician carry out inspection and maintenance operations.



- This device must be installed in a X-ray room that complies with current installation standards. From this location, Any visual or audio communication with the patient must be maintained by you and the Acquisition interface module during exposure.
- X-ray equipment is hazardous to patients and the operator if you do not comply with the exposure safety factors and operating instructions.
- This device must not be allowed to be operated if there is the threat of an earthquake. After an earthquake, ensure that the device is operating satisfactorily before using it again. Failure to observe patients to hazards.
- DO NOT place any objects within the field of operation of the device.
- Connect this equipment ONLY to a mains power supply with protective ground to avoid any risk of electric shock.
- Disposing of the device or its components must be executed by a qualified service technician.
- Never be allowed to modify the device.
- This device is never allowed to be applied in conjunction with oxygen-rich environments. Nor intended for apply with flammable anesthetics or flammable agents. Using accessories other than those specified in this document with the exception of those sold by Handy Health may result in a lower level of security for the entire system.

#### For Computer:

- DO NOT place the computer and the peripheral equipment connected to it in the immediate vicinity of the patient in the unit. Leave at least 1.5m distance between the patient and the unit. The computer and the peripheral equipment must conform to the IEC60950 standard.
- Read your computer installation guide for details of the data processing system and screen. Ensure the proper ventilation with leaving a sufficient amount of clear space around the CPU.
- In order to acquire maximum image quality and visual comfort, direct light reflections from internal or external lighting should be avoided when position the screen.

#### 3.7 Hygiene and Disinfection Instruction

- DO NOT place the sensor in an autoclave environment as which could cause serious damage to the sensor.
- Never immerse the RVG sensor in any solution.
- The sensor head should be disinfected after each patient.
- Do not apply chemical autoclave for the toothbrush holders and avoid direct contact with the metallic part of the autoclave.
- To prevent from cross-contamination, apply a new hygienic barrier for each new patient

#### 4. Handy Sensor General Introduction

Dental digital x-ray imaging system is consisted of sensor, image controller, image capture system and connection cable (USB port), connected with PC or notebook via USB cable. The power of controller and sensor is supplied by USB port, require no battery or power charge system. The whole equipment need to work together with imaging software.

#### 4.1 Functional Components

##### 4.1.1 HDR sensor



HDR-300/400

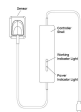

HDR-500/600

The sensor active surface is flat including the size 1 and size 2.

- ◆ Size1, universal sensor---Use for regular procedures, both for children and adult .
- ◆ Size2 sensor---Use for bitewings procedures.

The sensor non-reactive to X-Rays surface, contains the cable attachment.

Figure 2 HDR Sensor



1 Sensor non-reactive to X-Rays surface

2 Sensor active surface

#### 4.2 Technical Specifications

Sensor: APS CMOS sensor

External dimension (mm) :44.3×32.3(HDR-400/600) ; 38.5×27.5(HDR-300/500)

Sensor Active Area(mm) :36×27(HDR-400/600) ; 30×22.5(HDR-300/500)

Sensor Thickness : 6mm

Dynamic Range : 0-4,096

Power : 5V±0.5V

Image Transfer :USB2.0

Cable Length :≥ 3m(HDR-500/600) ≥ 2m(HDR-300/400)

#### 4.3 Sharing the Sensor Between Rooms under proper installation and operation

The sensor could be used under net version through HandyServer software and accessed by several dentists in different rooms as a working station . In this case, the HandyServer needs to be installed in one computer which is as the database and other computers in different rooms could access the data by remote.

Attentions: The HDR sensor and control box conform to the international safety standards and are regarded to be applicable to be used in patient available area, namely, within 1.5m distance. Within the patient available area, the (computer) devices used should be qualified as a medical device and is compliant with GB9706.1(IEC 60601-1), YY0505(IEC 60601-1-1) standards; outside the patient available area, the (computer) devices used other than a medical device should be compliant with GB4943(IEC 60950); the whole working station configurations should be compliant with GB9706.15(IEC 60601-1-2) standards and be verified by qualified station staffs. In order to ensure the device's normal performances, all programs used in the working station should be without virus and under verification .

#### 4.4 Using the different Positioning Systems

There are two ways to position the sensor in the patient mouth to get an classic radiology. You may spend some time to adapt due to the rigidity of the sensor.

One method is angular bisector technique, the other method is paralleling technique. It is just the way to position sensor, which can be chosen by practitioner's experience.

#### X-Ray Generator Compatibility

Normally, the sensor is compatible with all generators which meets the present standard of intraoral radiology. You can use a high frequency or conventional generator. To achieve gaining better images, the generator must operate with a voltage of **65 to 70kV**.

#### 4.5 Attentions

- 1 As a precision devices, avoid flop,pulling and long-time disinfectant soak
2. Put disposable plastic jackets before used, avoid cross infection and allergy
- 3.No bite, for fear that the sensor or the jacket been broken
- 4.Caution for epileptic or psychopath
- 5.Learn the user manual carefully before use
- 6.User should be the professional dental or technician

## 5. Imaging Software General Introduction

### 5.1 Computer System Requirements

Processor: Intel 1.7GHz chip or above;

Memory: Above 2G ;

Hard disk: Above 40G;

Interface: USB 2.0;

Display: Resolution 1024 × 758 (15") or above

Operating System: Windows 2000/XP/Win7/Win8/Win10 (32bit&64bit)

The computer connected to system shall be in accordance with IEC 60950-1:2005.

### 5.2 Imaging Software

The Handy HDR-300/500 and 400/600 dental imaging system operates with the following software:

- HandyDentist
- HandyServer for sharing information between workstations.

HandyDentist Software is a user-friendly working interface that was designed and developed specifically for radiological diagnosis. It is the common imaging platform for all our digital systems for dentistry.

### 6. Working Sketch

The sensor and control box is connected already, please check the light on control box, before taking x-ray image. The power indicator on the control box displays yellow light and working indicator flash green light.

#### Working Sketch map



HDR-300/400



HDR-500/600

## 7. Driver Installation

1. Insert the CD into CD-ROM or DVD drive, installation screen will appear,



2. Click on Install Driver, or browse CD then double click on the icon  to continue. It will show

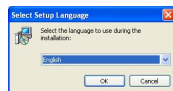

3. Click , it will show



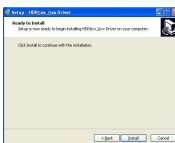

4. Click , it will show

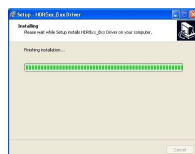

5. Click , it will show



6. Click , the driver is installed. Then connect the sensor to computer via USB cable, the computer will recognize it, and will show it is ready to use. You can check the drive name in Device Manager. The right driver name is  HDR5xx/Box Digital Intraoral Imaging Sensor .

## 8. Software Installation

We provide CD together with camera within the package. To begin the installation, insert the CD into your CD-ROM drive. The CD is equipped with an *Autorun* feature and will start on its own. If the *Autorun* feature does not work with the CD-ROM drive in your computer,

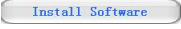

you can launch the installation menu manually: Double-click on the *My Computer* icon on your desktop, then open the CD-ROM drive by double clicking.

8.3.1. Click the button  on the interface of the CD or double-click the  icon in the CD, and then it shows:

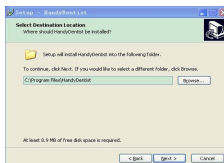

8.3.2. Click on the button , and then it shows:



8.3.3. The default destination folder is "D:/HandyDentist". If you want to change the route, please click on the button of to select the folder  you want. Then click on , and then it shows

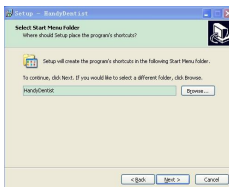

8.3.4. Click on , then it shows:

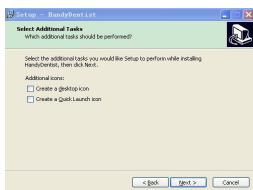

8.3.5. There are two selections for creating the icon, please make the selection according to your needs click **Next >**, then it shows:

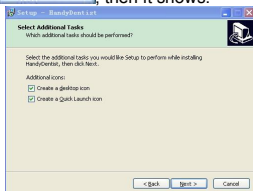

8.3.6. Click on the button **Next >**, then it shows:

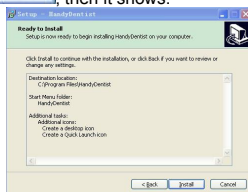

8.3.7. Click on **Install** the following window will be shown:

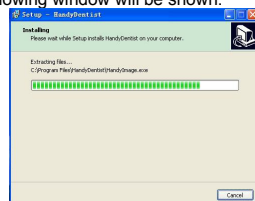

When the installation is finished, the following window will be show:



8.3.8. Then click on the button **Finish**, the whole installation was completed and the software will be launched automatically, and there will be a shortcut on the desktop.



## 9. Register Key

30 days later since the date of software installation, the software will ask for register. Double click on the target frame, register key windows will come.

Please remember to register the software within 30 days of installation.

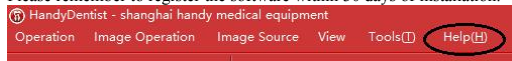

Click on Help in menu bar then select Register .



Input the information in the frame, and then click on Send Registration button, in normal situation, there will be a auto-run email jumping out.

If your computer have no email support server, you may meet the following notice.

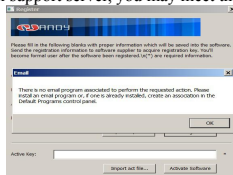

Please click on OK and then click on the button of Export Req file .

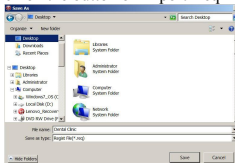

And then please send this Req file to email : [support@handycreate.com](mailto:support@handycreate.com)

As soon as we receive your req ,we will send back the registration key to you .



After you receive the registration file, please click on Import act file, and click on Active

Software button.

## 10 Install Calibration File

### 10.1 Install To Handydentist

Provided with every sensor is a disk containing the sensor calibration file. Each calibration file is unique to the sensor it was shipped with and the file must be installed on every computer systems before using that sensor. Every calibration file is consisted of 3 files , copy these 3 files from the CD and then paste into software installed destination folder , the default destination folder is D:/HandyDentist/Sensor. And then the calibration files installation is finished .

**10.2 Install to other software with Twain function. If you prefer to use your own software, pls follow this procedures.**

#### 10.2.1 Find the correct installation path.

Connect Handy sensor into the PC and open the software which you are going to use, then enter into Twain interface, see reference picture below:

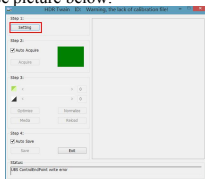

Click “Setting” then will show following picture (If the “Setting” button is in gray and can’t be clicked, please unplug the sensor and try again from the start.)

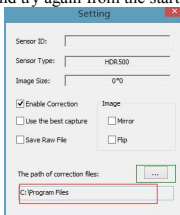

C:\Program Files” in red mark is the installation path for calibration files in Twain, or, you may change the path by clicking button in green mark and the new path you set will be the one for calibration files installation.

#### 10.2.2 Install the Calibration Files

Copy the 3 files under “Calibration file” in CD and paste them into the correct installation path file folder, then it’s finished.

## 11 Software Operation

### User interface

Double click on the icon  to launch the software, the HandyDentist window will be shown: Example Screen:

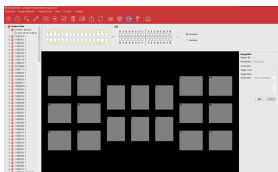

1. System menu of the program windows



2. Menu bar
3. Tool bar
4. Patient account list
5. Teeth chart
6. Target frame
7. Image information

### Menu Bar

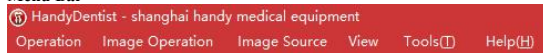

Each item contains a drop-down menu, and some of function can be achieved directly from the icon in toolbar

### Change language

Click on Tools(T) on the menu bar and select Option.

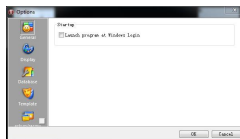

Click on Display, then select the your target language.



In Recent history part, there are two options, it arranges the order of First name and Last, this depends on countries custom .

Please click on OK, it will show



Click OK, the software will be restarted automatically and switch to be the language you selected.

### Toolbar

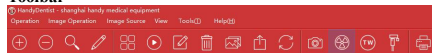

Each button contains a icon and will show a short message to explain corresponding function by moving the mouse pointer to the icon.

### Establish Patient account

1. Click the icon  in the toolbar or select new patient in file of menu bar



Then it will show

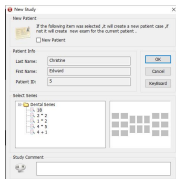

Input patient information ,select picture series and you can also input study comments in the frame and then click on OK . The new patient account has been created .

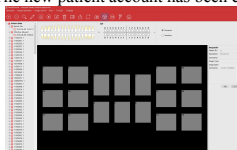

Target frame (18 pcs)

If the first one is full (Maximum 20 images for each account )

Click on  for creating another account under the same patient.

For establishing a account for another patient , please select “ new patient ” in this windows

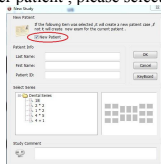

A new patient case has been created successfully.

**Delete patient account** 

Please select the patient case that you want to delete it will show the following notice window

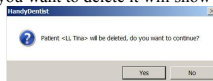

Click on “Yes”, and this patient will be deleted.

**Search a patient case** 

Click on this icon, and input the patient information, the target patient patient will be showed.

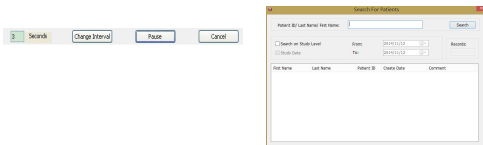

Input basic information of patient and click on search button to find a detailed patient account.

Please attention that the software only display 30 pcs recent patients case , all others will be hidden inside , so it need search tool if the patient case was not display in patient Data area .

### Edit basic information of patient

Click on this icon, and the *Patient Info* window will be show:



If there is something wrong with the basic information of the patient, it could be modified here.

### Tile

Pave several pictures together (the maximum quantity is 6).

Keep on pressing the “ctrl” on the keyboard for selecting several pictures at the same time, then click on this icon, and the pictures selected will be tiled.

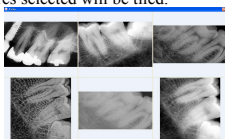

Press “ESC” to exit.

### Play

Click on this icon to view the image one by one.

The default time is 3 seconds and it could be changed depend on your requirement.

Press “ESC” to exit.

### Edit Image

Select a image then click on this icon to open “ Handy Image” windows, and you can also open it with double-click on the image. More information refers to 9.3.

### Delete Image

Select the image you want to delete then click on this icon. The following windows will show

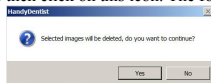

Choose “yes” or “no” to delete the image or not.

### File import

Select a picture from your computer.

### Export image

Select a captured image then click on this icon to export this image.

### Copy & Paste

Right click on the image, there will be a pull-down menu.

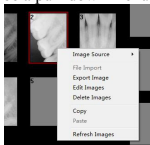

Select copy and then choose a empty target frame right click and select paste, this image will be paste into another frame.

### Refresh images

Click this icon to refresh the images, or  
Right click on any image, and then select Refresh images.

### Print Image

Note: To achieve this function, please be sure that the computer has been connected to a printer.  
*Print one image:* left-click on that target frame and then click on print icon in the tool bar directly.

*Print more images:* Keep on pressing the “ctrl” on the keyboard and then left click on the target frames to select several frames at the same time, then click on this icon to print these selected images.

**\* Before use the hardware, please click the equipment icon first:**

The icon  is for Intraoral Camera or Film Reader.

The icon  is for Intraoral X-ray Sensor.

The icon  is to make other third-party hardwares which have Twain function compatible to this software.

The icon  is for Panoramic Machine.

### HandyImage(Enhance image)

For enhancing the original image quality please double click the target frame with image or click on the button of  to come into HandyImage.



All of these feature buttons are use to change the attributes not the image itself.

All of these tools could be divided into six parts

#### **Color Adjust**

Color adjusted by moving the slider either to left or right depending on your needs.

#### **Bright/Contrast**

Brightness and contrast could be adjusted also by moving the slider to left the to decrease the brightness/contrast, move the slider to right to increase.

#### **Desoft**

To remove useless soft tissue and adjust gamma value to improve the image quality for those unsatisfied pictures:



Before

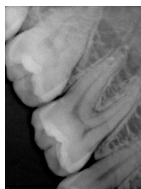

After

#### **Image process**

There are eight feature buttons listed in this section, to achieve its function just by clicking on corresponding button.

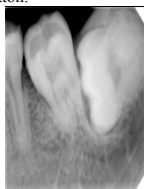

Before contrast

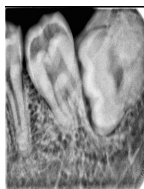

After contrast

#### **Smart contrast**

To enhance the contrast on the image

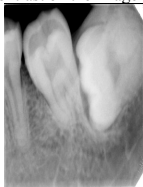

Before Sharpen

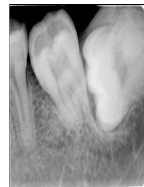

After sharpen

#### **Smart sharpen**

Inverts the gray shades of the image-negative images appear as positive, and positive images as negative.

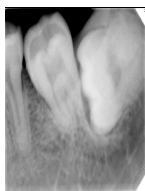

Before Negative

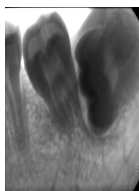

After Negative

Negative

Click on the colorize button, you'll notice the significant color contrast between different elements of the image. Because some differences can be easier to distinguish in color, colorizing provides another means to identify potential problems areas during examinations.

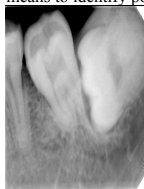

Before Colorize

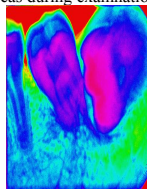

After Colorize

Colorize

This function can optimize your image.

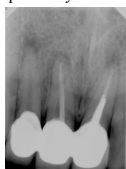

Before Embossment

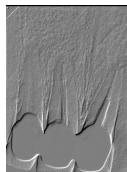

After Embossment

Embossment

Show better structures and improve underexpose or overexpose images' quality.

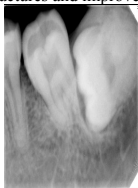

Before Normalize

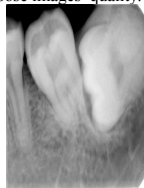

After Normalize

Normalize

Removes fixed pattern noise from an image.



Before

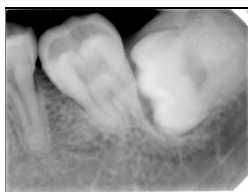

After

Denoise

Make the images smoother



Before



After

Soft

### Simulation Diagnosis

In order dentist have a better dental practice and more easy to diagnose for particular dentition. Saprodontia, Root Canal, Periodontal, Crown and Diagnosis, four different enhanced image make easier to check.

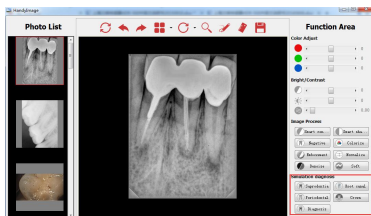

And With one button of Dignosis, you will see four different enhanced image.



## Handy Image Toolbar

To apply the function, click on corresponding button.



Apply this tool for come back to original image at one time .



Undo: Used to withdraw the previous operation



Redo: Used to repeat previous operation.

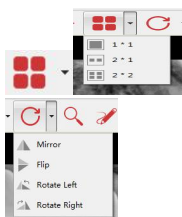

Choose the display mode you prefer.

This function is used to view the image from different angle .



Click this button, there's a small window for choosing the magnifier parameter you prefer.



This function was set for making a mark on the image the pinot out the tooth problem and for better communication between patient and dentist.



Click on this Drawing icon, then keep on left pressing of mouse, then move the pointer on the picture, the red line will appear following the mouse pointer .



Click on this icon, the following windows will show



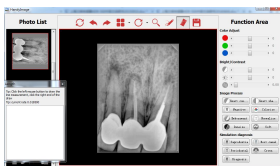

Left Click on two points that you want to know the distance. And left frame will show the distance, and this is only for reference, not accurate.

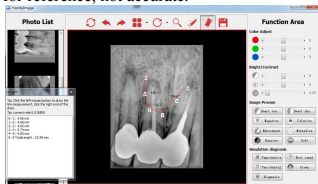

And if you calibrate the image taken from other brand sensor or intraoral camera, you will need calibrate first.



By Pressing this button the edited image will be saved automatically. And it will give the following notice.

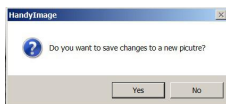

Click on OK, the edited image will be saved into software automatically.

## 12 Acquiring an Image

To acquire an image with the HDR sensor, follow the instructions in the presented order.

### 12.1 Preparing the HDR sensor

To prepare the HDR sensor, follow these steps:

Select an appropriate positioner for the region of interest and the sensor size.

Cover with a disposable hygienic sleeves specifically designed for each sensor size.





**Notice:** To prevent cross-contamination, use a new hygienic sleeve for each new patient.

### 12.2 Preparing for Acquisition

To prepare for acquisition, follow these steps:

1 Open software, establishing the patient account

2 Click  to access the capture interface,

or double click the blank frame .

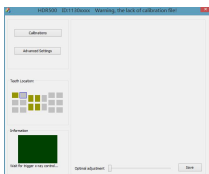

- 3 Select the x-ray timing according to the region of interest and the patient type (follow the user instructions of your x-ray generator).
- 4 Insert the sensor holding it horizontally in the patients mouth. Positioning in the patient's mouth depends on region of interest.
- 5 Approach the x-ray generator tube head to the patient.
- 6 Align the x-ray tube head with the patient's tooth and the sensor and make sure that the tube head is not shaking.

### 12.3 Launching the X-Ray

To launch the x-ray, follow these steps:

1. Ask the patient to remain still
2. Position yourself either 2 meters behind the x-ray generator or outside the door.
3. Keep visual contact with the patient during the x-ray generator.
4. Trigger the x-ray with the remote control of the capture generator.

The image appears in the capture windows of the capture interface.

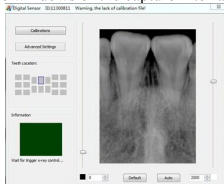

The image has been captured and the information frame return back to green color. It's ready to capture another image, without closing the window.

As soon as the image was captured it will be saved into software.

5. Check the image quality. If not satisfactory, redo the x-ray.
6. If satisfactory, remove the generator tube head.
7. Remove the HDR sensor from patient's mouth. Remove the hygienic sensor protection.



**Notice:** DO NOT pull the sensor by its cable when you remove the hygienic protection.

### 12.4 How to get X-Ray Image

Note: First of all, please confirm that you have installed the calibration files, more information refers to chapter 9.

#### Connect the sensor to the controller then connect it to computer

The power indicator light will shine, and then the working indicator light will flash green light.

#### Using disposable sheath

Please place the sensor on the holder and cover the sensor with disposable sheath, then place the sensor into patient's mouth with flat side facing the X-Ray tube.

#### Check the x-ray exposure settings.



Select one target frame, right click and select Intraoral X-Ray sensor and pls select HDR

NEW.

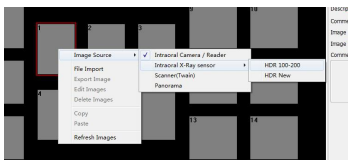

Double click on the target frame again, the capture windows will show:

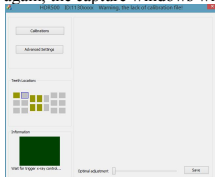

The capture windows will come and appear flash green light (default setting).

The sensor ID # of the sensor you are using is shown directly on the title.

And it will remind you if the calibration file hasn't been installed in the meanwhile.

Digital Sensor ID:11300811 Warning: the lack of calibration file!

#### Active the x-ray source.

After activate the x-ray source, the sensor will detect the x-ray automatically and it will show .

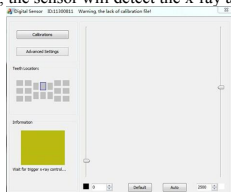

The green flash frame will change to be yellow color, it means that the sensor has detected the x-ray successfully. And around two seconds later, the image will be captured as below show.

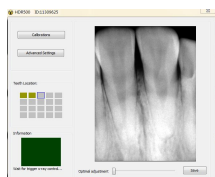

#### Advanced Settings

If you find out that some images need do some imaging process to enhance the image quality, you can use Advanced Settings

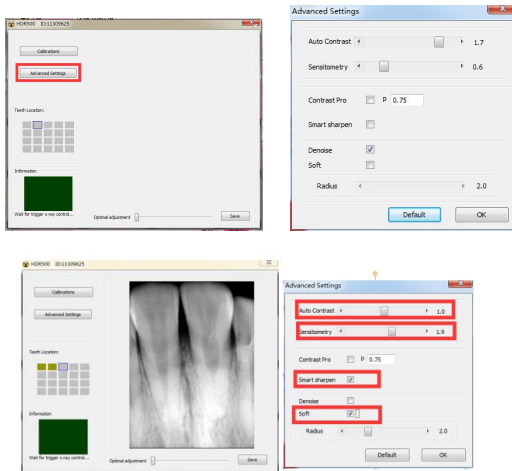

And you can slide these buttons one the left to adjust to what you expect on the right side, and next time you will take the image just exactly you want to enhance without any other action.

**\*\*However, we will recommend you keep the default figures in normal cases.\*\***

**\*\* To optimize the final image processing quality, please adjust the window level first and save to a new picture, then using processing function buttons on this saved new picture. \*\***

The image has been captured and the information frame return back to green color .It's ready to capture another image ,without closing the window .  
As soon as the image was captured it will be saved into software .

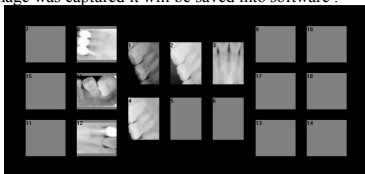

For taking another x-ray image, please repeat this procedure.

**! Important:** When the device is not in use, please disconnect it from USB port to avoid LED indicator be over heated.

**! Important:** The disposable sheath is for single use only; please change it for every patient and dispose the used ones under local health authorities guidance on medical disposable products.

**! Important:** The disposable sheath used shall conform to ISO10993 biocompatibility requirements, i.e. no cytotoxic, delayed type hypersensitivity, irritation or endothelial reaction.

Working Sketch map

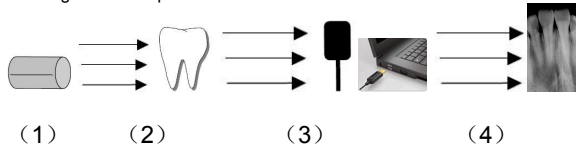

**Descriptions:**

- (1) x-ray source
- (2) Tooth
- (3) Digital x-ray sensor
- (4) Connect to computer via USB cable
- (5) Show the image in software

**13. Disinfection and cleaning**

 The product can't be dipped in liquids, and the disinfectants and cleaning agents should not be used. The product shall be used with disposable sheet to achieve the disinfectant purpose (Handy Company do not provider disposable sheets, please use the disposable sheets which are compliant with ISO10993 biocompatibility requirements). Periodically clean the outside of the controller and the sensor by soft cloth with a small quantity of alcohol. The disinfection and cleaning preparations could damage the CMOS-sensor or the controller. The usage of disinfection and cleaning preparations is considered to be a breach of the guidelines for intended use. The manufacturer cannot be held liable for any damage resulting from incorrect usage. The operator will be held liable and bears all risks.

·Do not put sensor in an autoclave.

- Do not put the sensor in an ultrasonic bath for cleaning and disinfecting.
- Avoid spraying any of the connectors to the CMOS-sensor!
- Remove coarse dirt before disinfection using a soft, lint-free cloth or wipe.

**14. Maintenance**

**14.1. Visual Inspection**

Like all electrical equipment, the product requires not only correct use, but also visual inspection prior to operation, and routine checks at regular intervals. These precautions will help ensure that the product operates accurately, safely, and efficiently.

Before operating the system, users shall check it for any signs of physical damage or defect. If detected, contact your local distributor of this product for further instructions.

**14.2. Periodic Maintenance**

Periodic maintenance is performed as needed, but at least once a month. It consists of various checks performed by the operator or by a qualified service technician.

- Check that the labels are intact, readable, and adhere well to the surfaces on which they are positioned
- Check that all of the cables are undamaged
- Check that there is no external damage to the product which could compromise its ability to operate safely
- Check the installation, then do the step 1, 2 and 5 of operation and check that the indicator lights and indicator area in software are in normal.

#### 14.3. Cable Care

Improper coiling of a sensor's cable is the most common cause of the sensor failure.

The following instruction is important to be followed for preventing cable damage.

- Grasp the connector off the sensor cable when disconnecting the sensor from USB control box. Pull it gently.
- Once unpacked, never coil the sensor cable, repeated coiling may cause kinks and irreversible damage.
- Store the sensor in its holder when it's not in use.
- Don't let the cable hang on or near the floor where can become tangled.
- Don't tangle the cable during use.

Note: The length is actual only when it was calibrated. If not, the value is just for reference.

#### 14.4. Damaged or Non-Functioning Sensor

In the event of obvious physical damage to the Sensor or in the event that the sensor can't work properly, customers shall discontinue use of the Sensor, and contact their local distributor of the products to substitute another Sensor if available.

#### 15. Warranty

We guarantee that the product functions correctly and that there are no faults in the material or workmanship for duration of 12 months following the purchase date, according to the following conditions:

Following a reasonable complaint relating to defects or short delivery, we will provide a replacement or perform repairs. Our factory reserves the right to perform repairs.

Claims of any other nature, damages in particular, are excluded. In case of default and gross negligence or intent, the latter only applies if there are no compelling legal provisions opposing it.

We shall not be liable for defects or their consequences if they are likely to be a direct result of actions or modifications by a customer or third party.

The service life of the product is 4 years without unexpected situation.

#### 16. Adjust exposure x-ray dose.

Just like the traditional exposure machine, expose time depend on the machine model, and the patient exposed tooth part. Following is our recommend for your reference. You can adjust and set the setting to needs to take more clear images based on your experience.

Tooth position	Exposure time
	Seconds
<b>Adult with #1 or #2</b>	
Upper incisor/canine	0.18
Upper premolar	0.24
Upper molar	0.40
Lower incisor/ canine	0.12
Lower premolar	0.18
Lower molar	0.24

### 17.Diagnose Error Message

- 1.Computer can't recognize the sensor  
Try another USB port and reinstall the driver program
- 2.Controller box does not work(the dedicator light out)  
Check the connect interface between controller box and computer
- 3.Can't capture picture  
Set the x-ray machine. Try plug to the back USB port of computer case , and reinstall the driver program.
- 4.No capture program  
Close all anti-virus program and reinstall all program
- 5.Warning "Lack of calibration file"  
Pls copy the calibration file from CD to dedicate folder,the default folder is C:\Program Files\Handydentist\sensor
- 6.The image taken is too dark or white  
Try to reduce or increase x-ray dose and exposure time
- 7.Can't use the handydentsist software over a month.  
Please export the req to us for the active file to register the software.
- 8.The image taken has the white vertical light  
Did not install calibration file or calibration file is installed in wrong place.

#### Annex A. EMC table

The following tables provide HDR compliance information to electromagnetic compatibility (EMC) and electromagnetic immunity (EMI) standards. To ensure conformance, the customer or user must use the HDR in environments that are consistent with these standards. USB cables used with HDR Interfaces must also comply with the same standards.

Table 1. Guidance and Manufacturer's Declaration - Electromagnetic Emissions

*PLEASE NOTE: HDR is intended for use in the electromagnetic environment specified below. The customer or user of HDR must ensure that it is used in such an environment.*

Emissions Test	Compliance	Guidance
RF emissions EN 55011	Group 1	HDR uses RF energy only for its internal function. Therefore, its RF emissions are very low and are not likely to cause any interference in nearby electronic equipment.
RF emissions EN 55011	Class B	HDR is suitable for use in all establishments, including domestic establishments and those directly connected to the public low-voltage power supply network that supplies buildings used for domestic purposes.
Harmonic emissions EN 61000-3-2	N/A	
Voltage fluctuations/flicker emissions EN 61000-3-3	N/A	

Table 2. Guidance and Manufacturer's Declaration - Electromagnetic Immunity

*PLEASE NOTE: HDR is intended for use in the electromagnetic environment specified below. The customer or user of HDR must ensure that it is used in such an environment.*

Immunity Test	EN 60601 Test Level	Compliance level	Electromagnetic environment Guidance
Electrostatic discharge (ESD) EN 61000-4-2	±6 kV contact ±8 kV air	±6 kV contact ±8 kV air	Floors should be wood, concrete or ceramic tile. If floors are covered with synthetic material, the relative humidity should be at least 30%.
Electrical fast transient/burst EN 61000-4-4	±2 kV for power supply lines ±1 kV for input/output lines	N/A	Mains power quality should be that of a typical commercial or hospital environment.
Surge EN 61000-4-5	±1 kV differential mode ±2kV common mode	N/A	Mains power quality should be that of a typical commercial or hospital environment.
Voltage dips, short interruptions and voltage variations on power supply input lines EN 61000-4-11	< 5% UT (≥95% dip in UT) for 0.5 cycle 40% UT (60% dip in UT) for 5 cycles 70% UT (30% dip in UT) for 25 cycles < 5% UT (≥95% dip in UT) for 5 sec	N/A	Mains power quality should be that of a typical commercial or hospital environment. If the user of HDR requires continued operation during power mains interruptions, it is recommended that the HDR be powered from an uninterruptible power supply or a battery.



Power frequency (50/60 Hz) magnetic field EN 61000-4-8	3A/m	3A/m	Power frequency magnetic fields should be at levels characteristic of a typical location in a typical commercial or hospital environment.
Conducted RF EN 61000-4-6	3 Vrms 150 kHz to 80 MHz	3 V	Portable and mobile RF communication equipment should be used no closer to any part of HDR, including its cables, than the recommended separation distance calculated from the equation applicable to the frequency of the transmitter. Recommended separation distance: $d = \left[ \frac{3.5}{Y_1} \right] \sqrt{P}$
Radiated RF EN 61000-4-3	3 V/m 80 MHz to 2.5 GHz	3 V/m	$d = \left[ \frac{3.5}{E_1} \right] \sqrt{P}$ for 80 MHz to 800 MHz $d = \left[ \frac{7}{E_1} \right] \sqrt{P}$ for 800 MHz to 2.5 GHz Where P is the maximum output rating of the transmitter in watts (W) according to the transmitter manufacturer and d is the recommended separation in meters (m). Field strengths from fixed RF transmitters, as determined by an electromagnetic site survey, <sup>a</sup> should be less than the compliance level in each frequency range. <sup>b</sup> Interference may occur in the vicinity of equipment marked with the following symbol. 
NOTE 1: At 80 MHz and 800 MHz, the higher frequency range applies. NOTE 2: These guidelines may not apply in all situations. Electromagnetic propagation is affected by absorption and reflection from structures, objects and people			
<p>a Field strengths from fixed transmitters, such as base stations for radio (cellular/cordless) telephones and land mobile radios, amateur radio, AM and FM radio broadcast and TV broadcast cannot be predicted theoretically with accuracy. To assess the electromagnetic environment due to fixed RF transmitters, an electromagnetic site survey should be considered. If the measured field strength in the location in which the HDR is used exceeds the applicable RF compliance above, HDR should be observed to verify normal operation. If abnormal performance is observed, additional measures may be necessary, such as reorienting or relocating the HDR.</p> <p>b Over the frequency range 150 kHz to 80 MHz, field strengths should be less than 3 V/m</p>			

Table 3. Recommended Separation Distance between Portable and Mobile RF Communications Equipment and HDR  
 PLEASE NOTE: HDR is intended for use in an electromagnetic environment in which radiated RF disturbances are controlled. The customer or user of HDR can help prevent electromagnetic interference by maintaining a minimum distance between portable and mobile RF communications equipment (transmitters) and HDR as recommended below, according to the maximum output power of the communications equipment.

Rated maximum output power of the transmitter (W)	Separation distance according to the frequency of the transmitter (m)		
	150 kHz to 800 MHz $d = \left[ \frac{3.5}{V_1} \right] \sqrt{P}$	80MHz to 800MHz $d = \left[ \frac{3.5}{E_1} \right] \sqrt{P}$	800 MHz to 2.5 GHz $d = \left[ \frac{7}{E_1} \right] \sqrt{P}$
0.01	0.12	0.12	0.23
0.1	0.38	0.38	0.73
1	1.2	1.2	2.3
10	3.8	3.8	7.3
100	12	12	23
For transmitters rated at a maximum output power not listed above, the recommended separation distance d in meters (m) can be estimated using the equation applicable to the frequency of the transmitter, where P is the maximum output power rating of the transmitter in watts (W) according to the transmitter manufacturer. NOTE 1: At 80 MHz and 800 MHz, the separation distance for the higher frequency range applies. NOTE 2: These guidelines may not apply in all situations. Electromagnetic propagation is affected by absorption and reflection from structures, objects, and people			